

**RUPALA EXIM LLP**

INDIA

[www.rupalaexim.com](http://www.rupalaexim.com)

[info@rupalaexim.com](mailto:info@rupalaexim.com)

whatsapp/call: +91 9104014206



**RIL\_1 MM\_HP LAMINATES**

**alluring**  
essence





# index



- BOHEMIAN ▶ 06-07
- PLUSH TOUCH ▶ 08-11
- ABSTRACT ▶ 12-13
- MODISH WOOD ▶ 14-15
- ELAN AURA ▶ 16-17
- CLASSIC ▶ 18-21
- ELITE TOUCH ▶ 22-27
- MAJESTIC ▶ 28-29
- NICHE NATURE ▶ 30-33
- SUBTLE TEAK ▶ 34-35
- PLUSH PENCHANT ▶ 36-38
- CLASSIC FABRIC ▶ 39

VIBRANT  
CODE- HGL  
81

SUBTLE  
TEAK  
04-05

SPLENDOR  
WONDER  
40-41

- ELAN AURA ▶ 42-47
- MAJESTIC ▶ 48-49
- BOHEMIAN ▶ 50-51
- SLEEK TENOR ▶ 52-53
- CONTEMPORARY ▶ 54-57
- ENGAGING ▶ 58-59
- PERFECTION ▶ 60-63
- RUGGEDNESS ▶ 64-65
- URBANITY ▶ 66-67
- VOGISH VEIN ▶ 68-71
- SUEDE FINISH ▶ 72-79
- VIBRANT CODE- SF ▶ 80



SUBTLE  
TEAK



*metamorphosis of*  
**artistry**



USED LAMINATE  
IT-52 - 4140 ◆◆

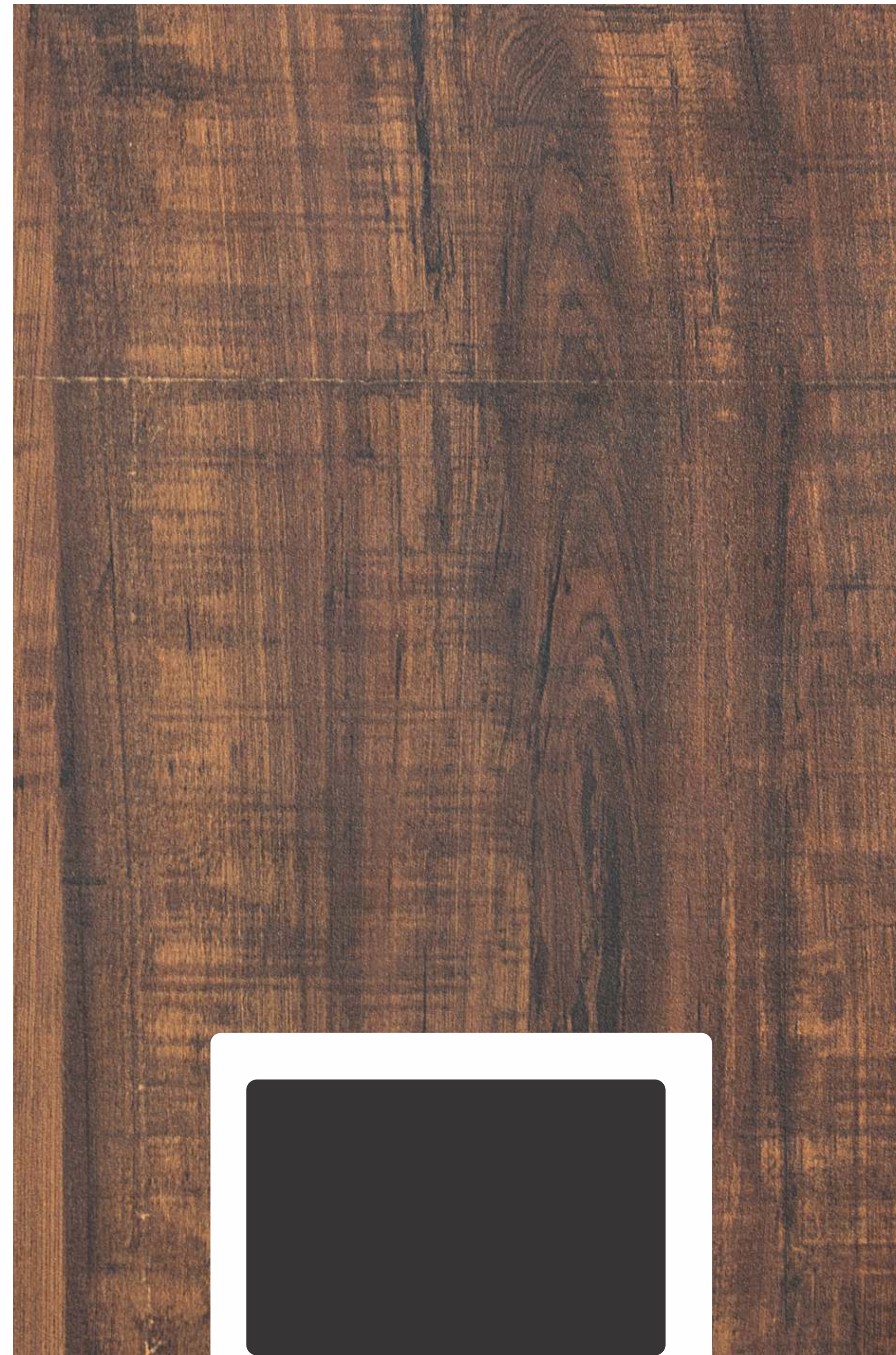

IT-52 - 4140 | SEDONA RED

IT-48 - 430 | BLACK





# BOHEMIAN



IT-27 - 4107 | DEEP HEMLOCK

IT-27 - 4106 | GRAINY CEDAR



*contemporary rage*  
**exemplified**



USED LAMINATE  
IT-27 - 4106 ◆◆

USED LAMINATE  
IT-27 - 4107 ◆◆





PLUSH  
TOUCH



IT-43 - 4135 | ESPRESSO ASH

*brisk breath of*  
**brilliance**

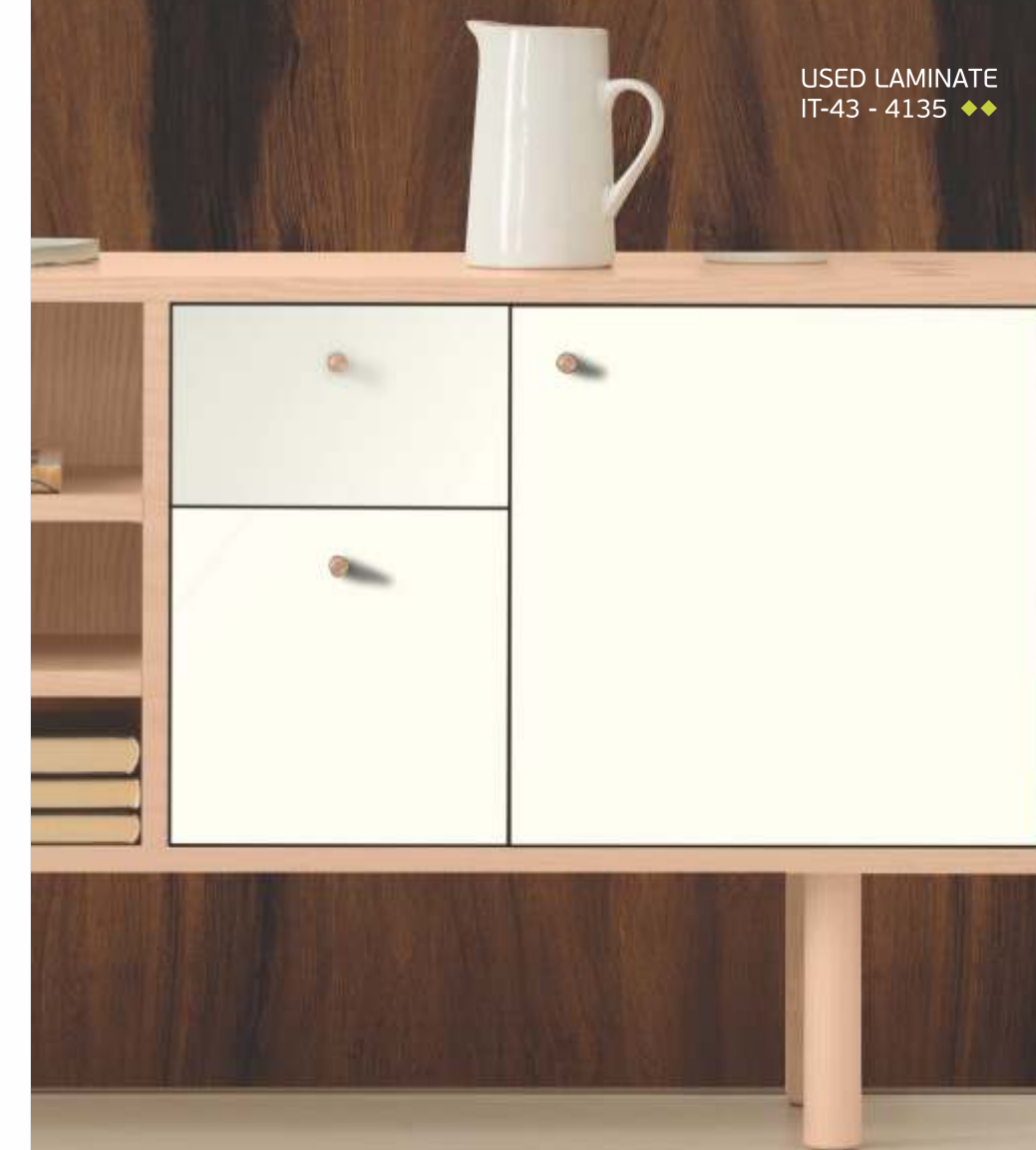

USED LAMINATE  
IT-43 - 4135 ◆◆

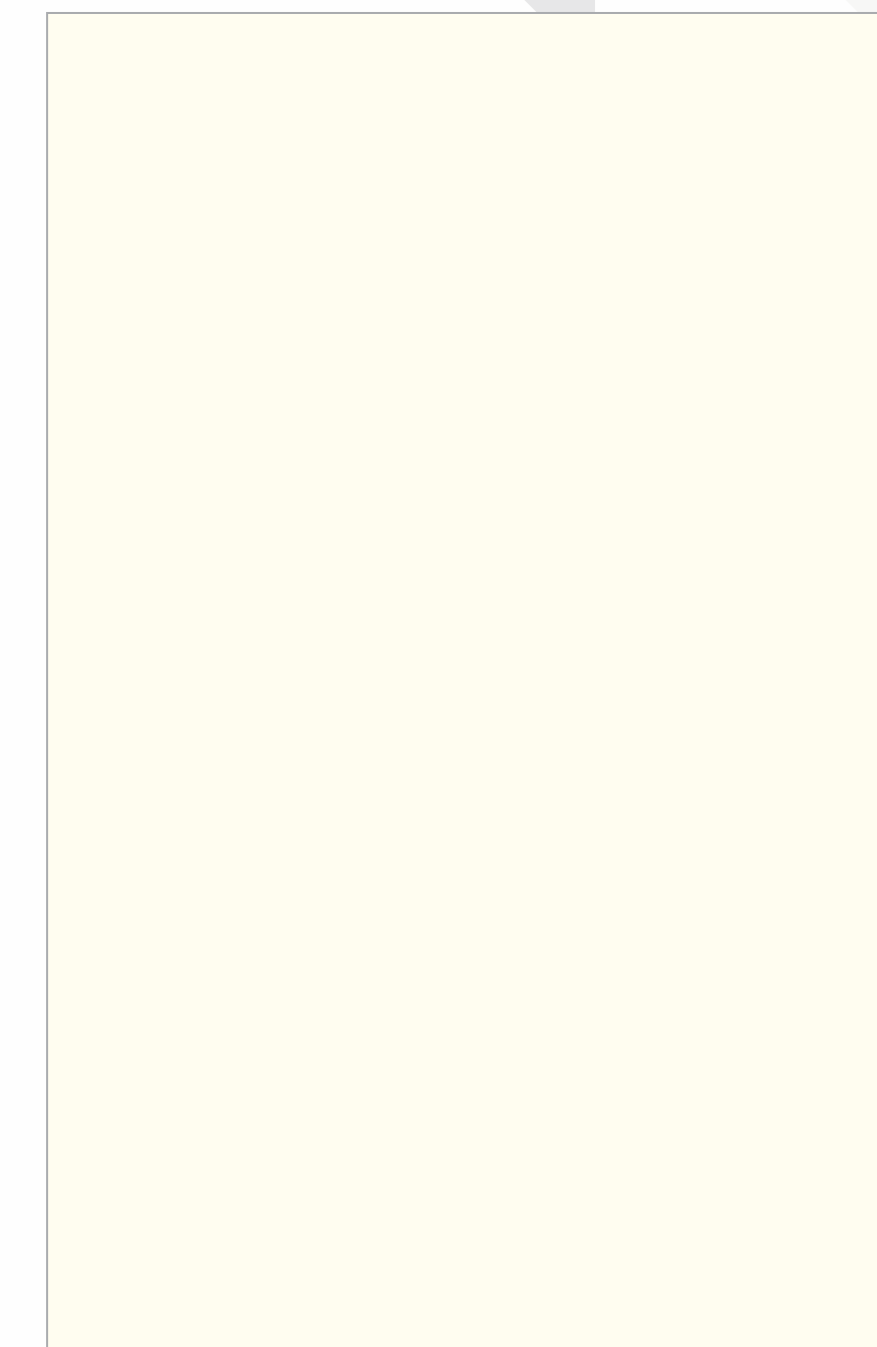

IT-43 - 406 | FROSTY WHITE



PLUSH TOUCH



IT-43 - 4131 | BRIARWOOD



*bridging the urban elite*  
**nuance**

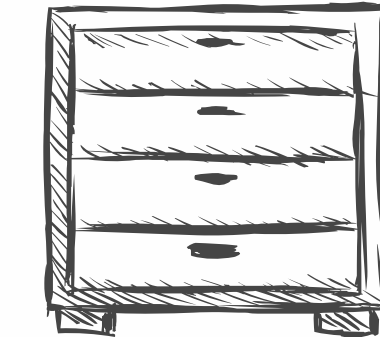

IT-43 - 4127 | SIENNA MAPLE



IT-43 - 4130 | LINEAR TEAK

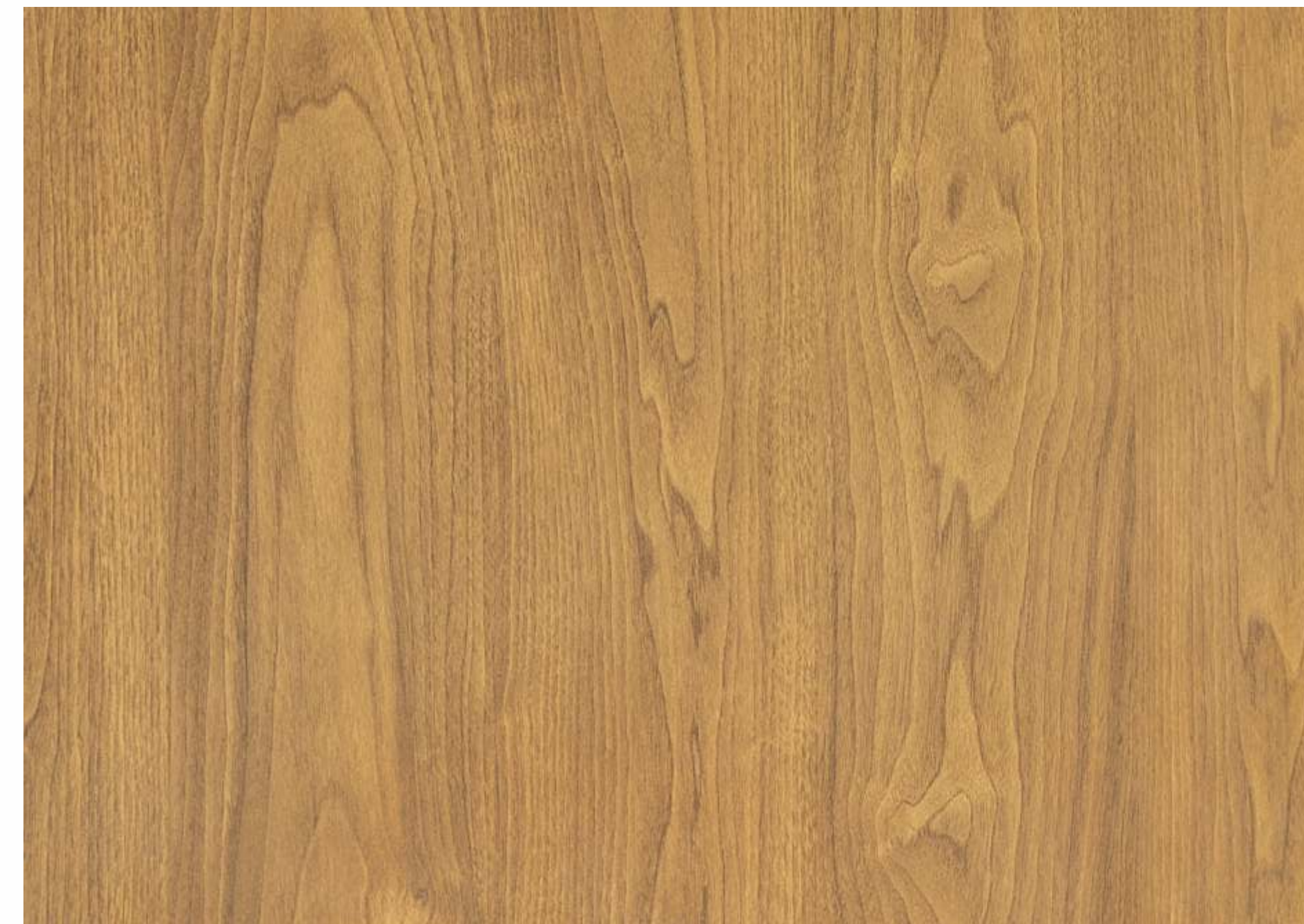

IT-43 - 4134 | GOLDEN WALNUT



ABSTRACT

USED LAMINATE  
IT-31 - 4126

range of riveting  
**charm**



IT-31 - 4126 | TEAK TRIMMED



IT-31 - 4111 | FRESCO GREY

IT-31 - 4112 | BLACK PATTERNIA



MODISH  
WOOD



IT-35 - 4107 | DEEP HEMLOCK

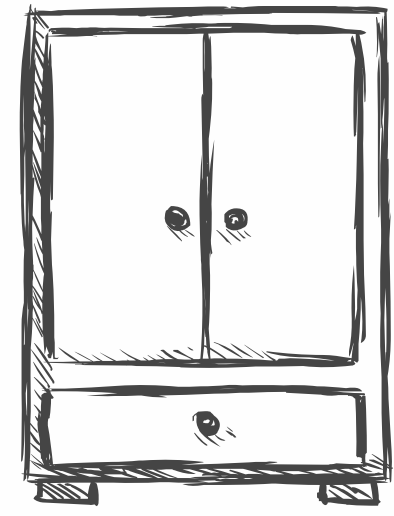

IT-35 - 4106 | GRAINY CEDAR

*precious possessions*  
**of pride**



IT-35 - 4132 | LUSHIOUS OAK



IT-35 - 4141 | SLEEK WALNUT



ELAN  
AURA



IT-41 - 4102 | SPHERICAL PINE

*nature has a sagacious*  
**saga**

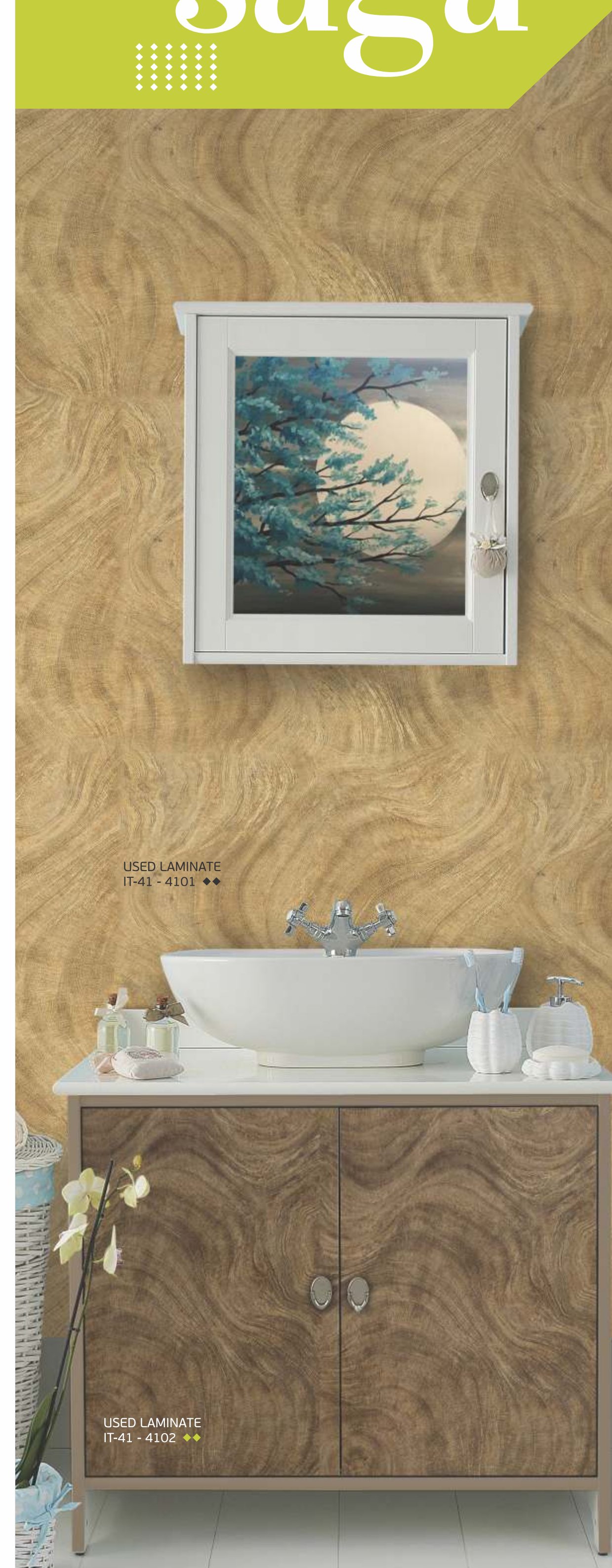

USED LAMINATE  
IT-41 - 4101 ♦♦

USED LAMINATE  
IT-41 - 4102 ♦♦



IT-41 - 4101 | BUFF BROWN



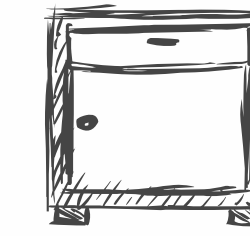

CLASSIC



IT-46 - 4119 | WISHFUL GREY



USED LAMINATE  
IT-46 - 4120

USED LAMINATE  
IT-46 - 4119



IT-46 - 4120 | BROWN CINNAMON

*eminence of authentic*  
**edge**



CLASSIC

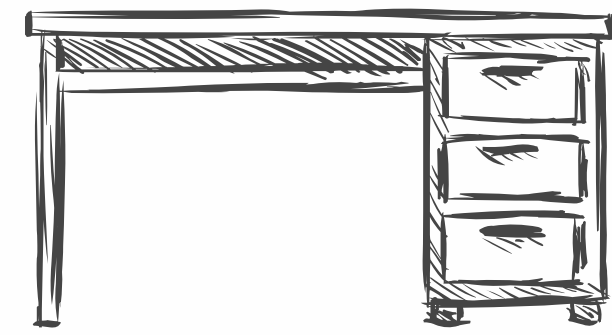

*extreme end of*  
**exquisite**



IT-46 - 4140 | SEDONA RED



IT-46 - 4133 | PROVINCIAL BROWN



IT-46 - 4132 | LUSHIOUS OAK



IT-46 - 4137 | ELITE JACOBAN



ELITE TOUCH

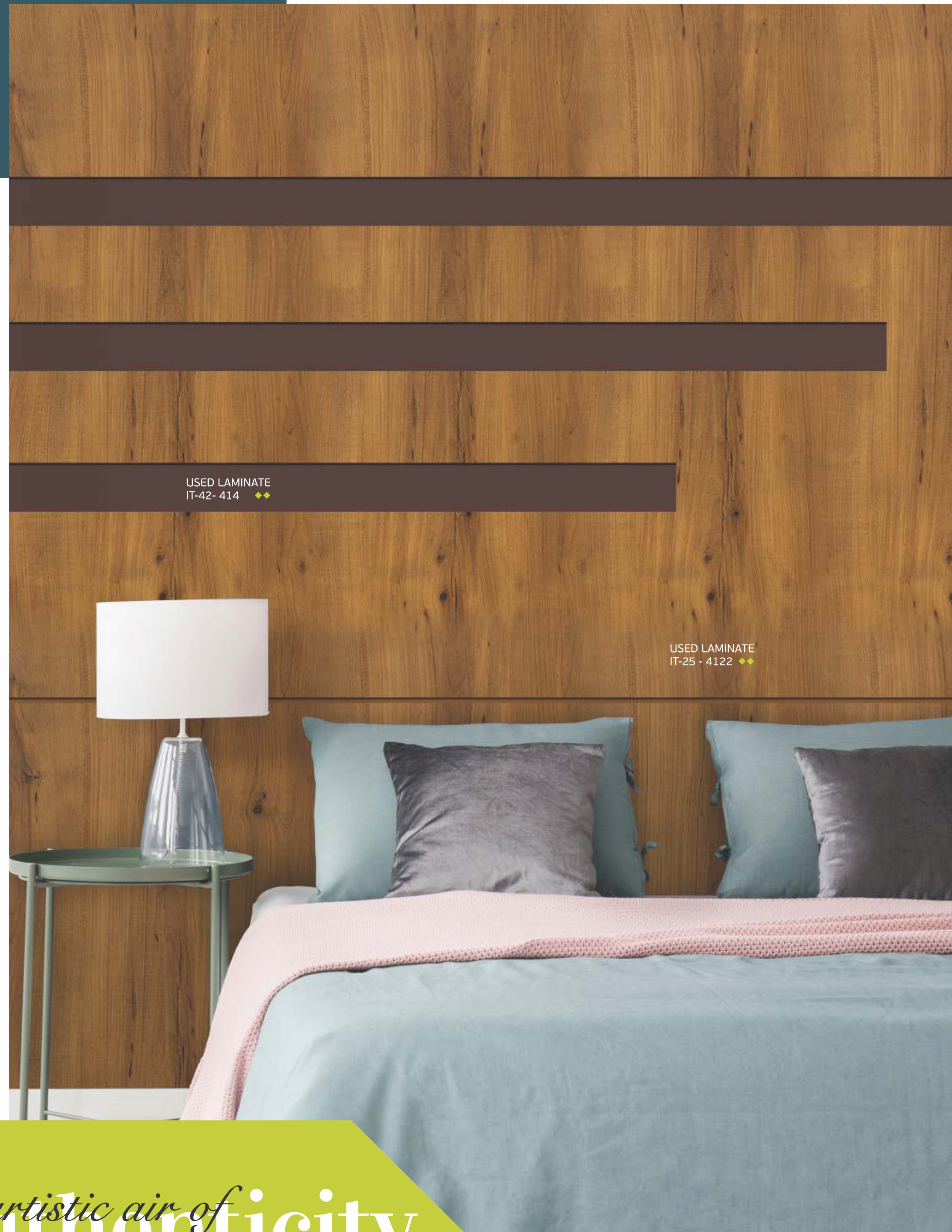

USED LAMINATE  
IT-42 - 414 ◆◆

USED LAMINATE  
IT-25 - 4122 ◆◆

*artistic air of*  
**authenticity**

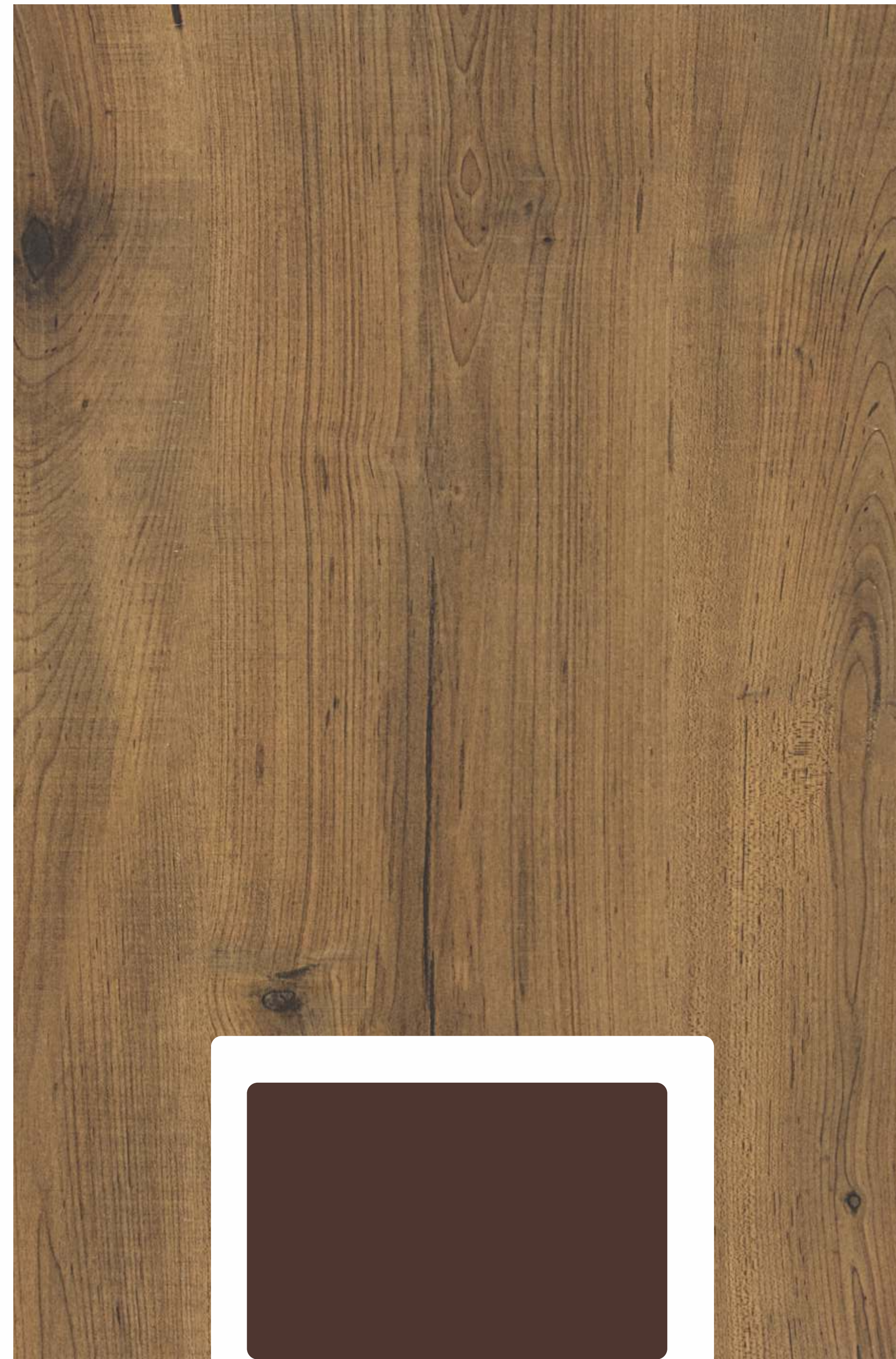
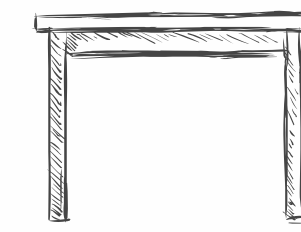

IT-25 - 4122 | COGNAC OAK

IT-42 - 414 | BROWN



ELITE TOUCH

*rich demeanor of supreme*  
**league**



IT-25 - 4135 | ESPRESSO ASH



IT-25 - 4133 | PROVINCIAL BROWN



IT-25 - 4131 | BRIARWOOD



IT-25 - 4120 | BROWN CINNAMON



IT-25 - 4123 | MESH MAHOGANY



ELITE TOUCH



IT-25 - 4124 | SOFT CYPRESS



IT-25 - 4125 | DRIFTWOOD



*flaunt the niche*  
**grace**



IT-25 - 4134 | COFFEE BROWN



IT-25 - 4126 | TEAK TRIMMED



USED LAMINATE  
IT-25 - 4125





# ST NEX

This collection is one of its kind with renditions of fine form inscribing stone textures full of precision, finesse and ethereal elegance of grandiose appeal.

*impressions of artistic*  
**excellence**



MAJESTIC



IT-51 - 4603 | MARVELLIA GREY

[www.rupalaexim.com](http://www.rupalaexim.com)



*modish & minimalist*  
**terrain**



USED LAMINATE  
IT-51 - 4603 ◆◆



IT-51 - 4604 | BRISKISH BEECH

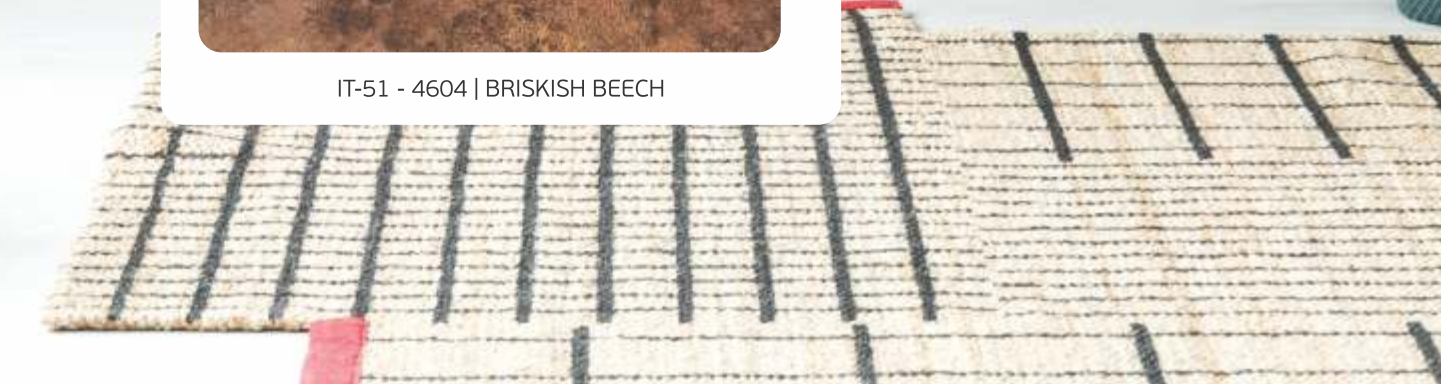



avant garde flair of  
**nature**

NICHE  
NATURE



IT-50 - 4103 | RUGGED BEECH



USED LAMINATE  
IT-50 - 4103 ◆◆

USED LAMINATE  
IT-50 - 4104 ◆◆



IT-50 - 4104 | CREMA ASH



NICHE  
NATURE



IT-50 - 4115 | TEAK REALM



IT-50 - 4122 | COGNAC OAK



IT-50 - 4129 | BROWN CHESTNUT



IT-50 - 4130 | LINEAR TEAK

*mesmeric mode of*  
**aesthetics**





SUBTLE  
TEAK



USED LAMINATE  
IT-52 - 4136 ◆◆

USED LAMINATE  
IT-52 - 4126 ◆◆

*ethos of elegant*  
**dimensions**

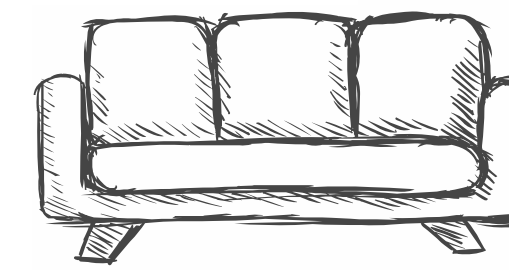

IT-52 - 4136 | GLAUCOUS GREY

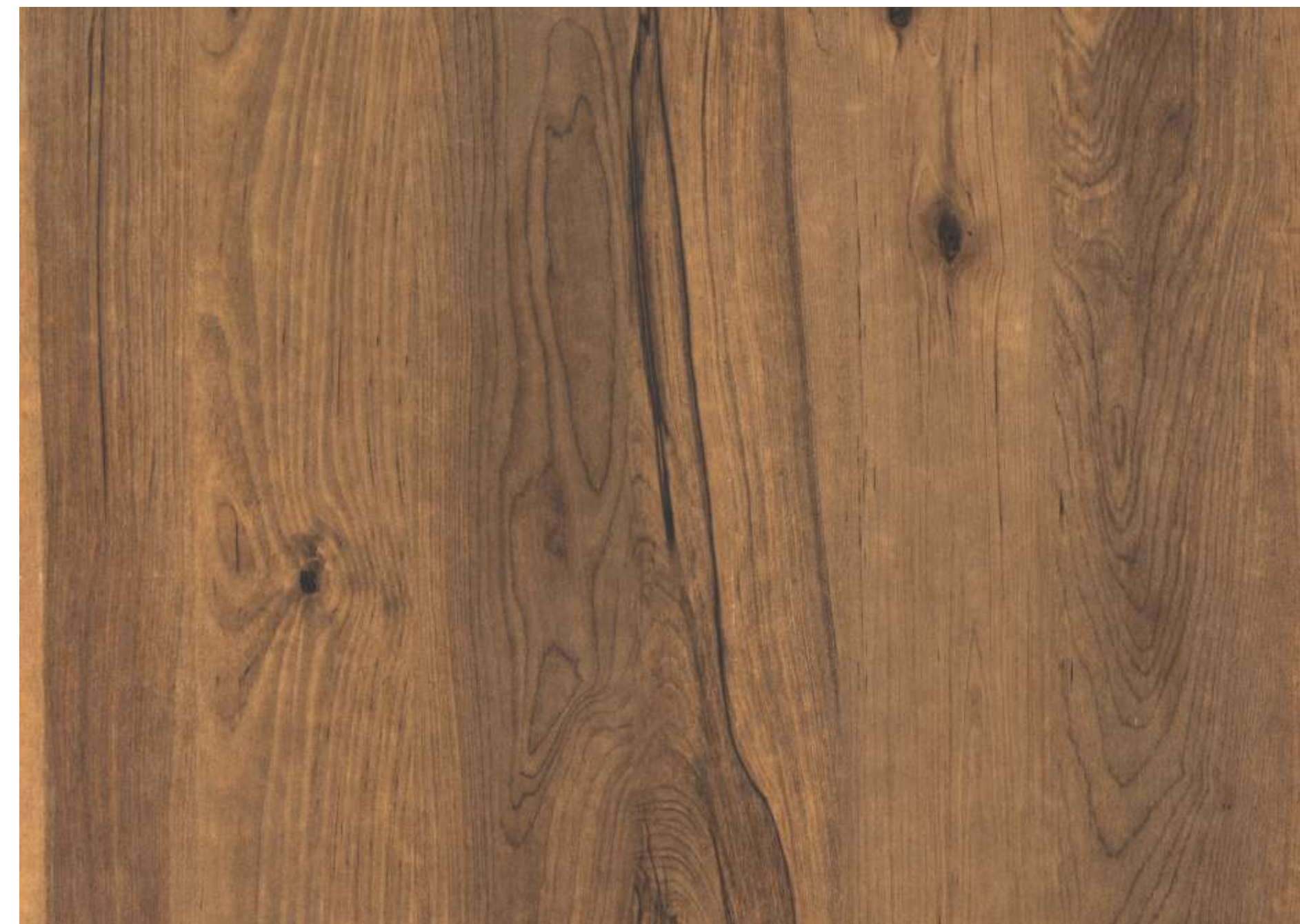

IT-52 - 4126 | TEAK TRIMMED





# PLUSH PENCHANT



IT-48 - 4504 | GREY DAZZLE



IT-48 - 4503 | SLATE GREY



IT-48 - 43501 | WHITE FABRIC



IT-48 - 43502 | BLUE FABRIC

welcome the dash of  
**dazzle**



# PLUSH PENCHANT



IT-48 - 4117 | PECAN STREAK



USED LAMINATE  
IT-48 - 4117



IT-48 - 4118 | LAYERED NUTMEG

# CLASSIC FABRIC



IT-29 - 4502 | STONE GREY



IT-29 - 4501 | CINEREOUS GREY

*captivating verve of*  
**curiosity**



SPLENDOR  
WONDER



*charm of*  
**WOODART**

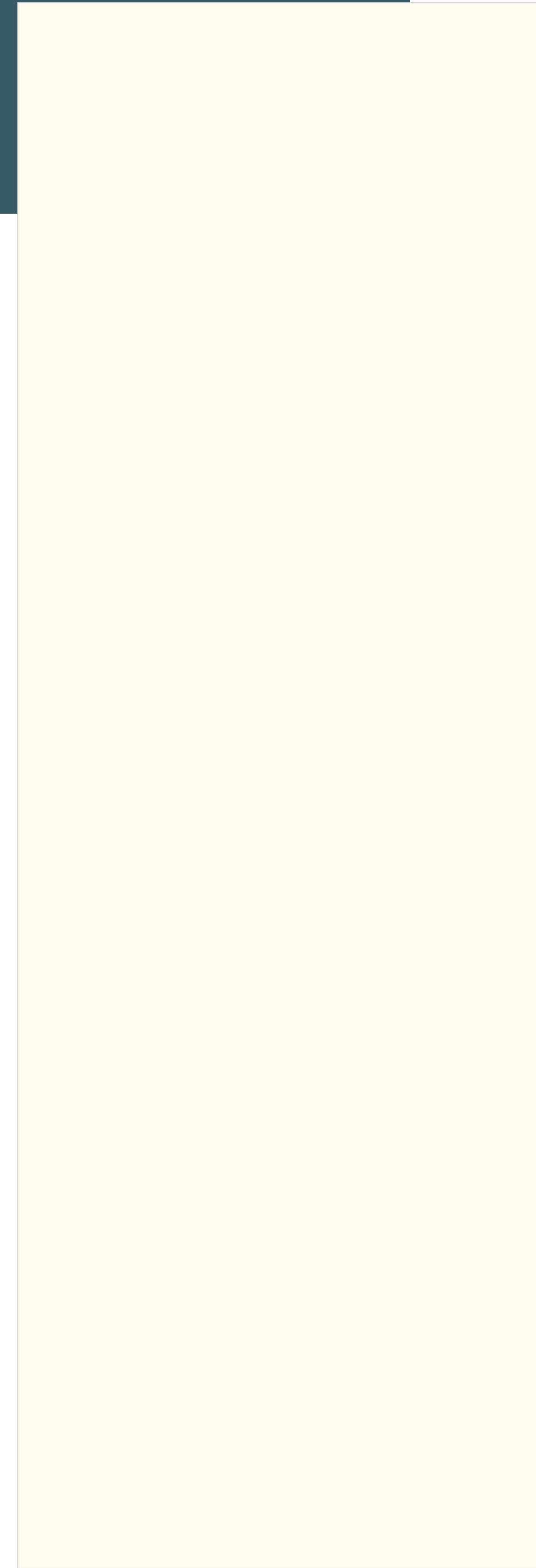

IT-53 - 406 | FROSTY WHITE



USED LAMINATE  
IT-53 - 4127

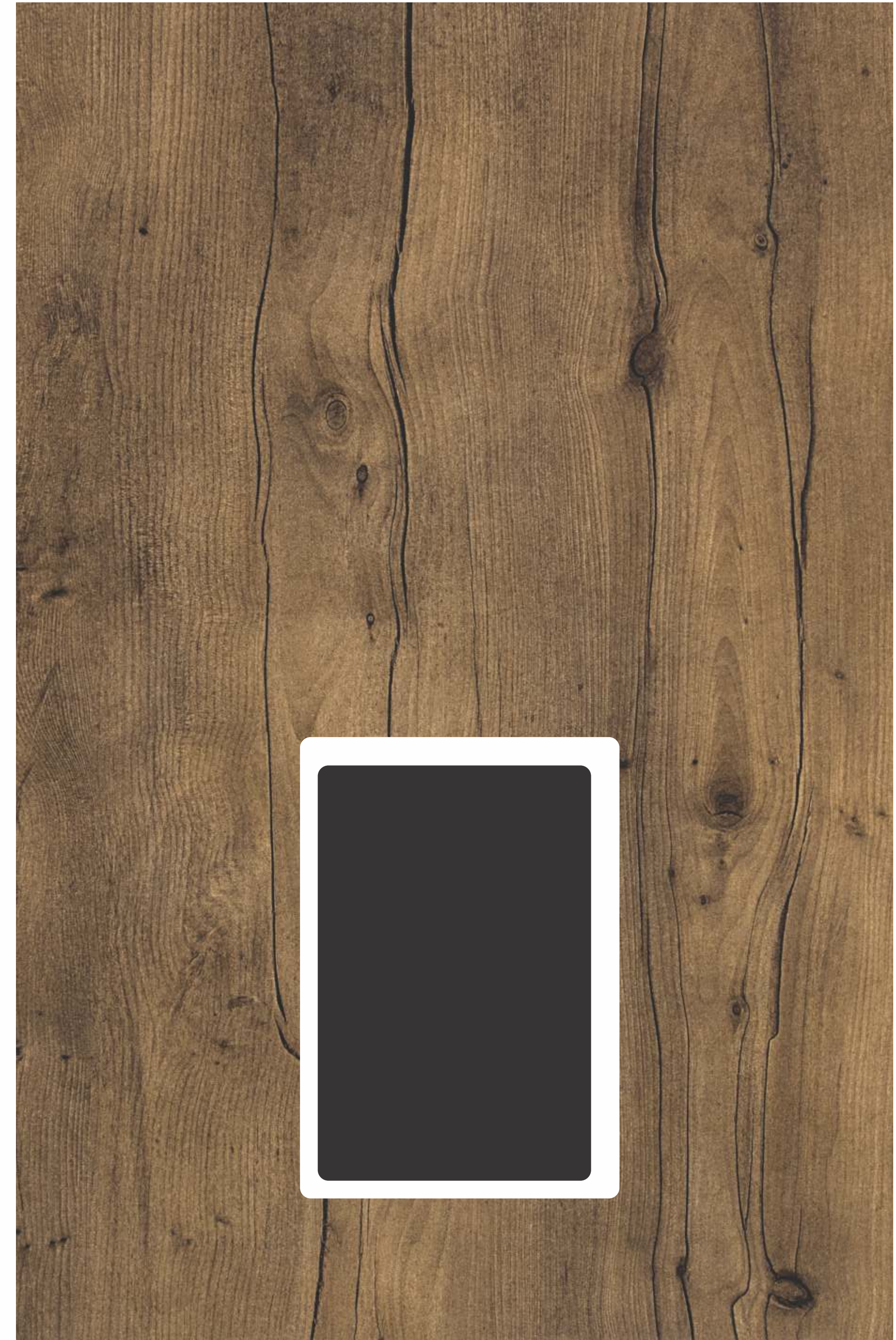

IT-53 - 4127 | SIENNA MAPLE

IT-53 - 430 | BLACK



ELAN  
AURA



IT-41 - 4606 | CAROB MODERNO



IT-41 - 4605 | MARBELLIA WHITE

*resplendency is in*  
**the air.**

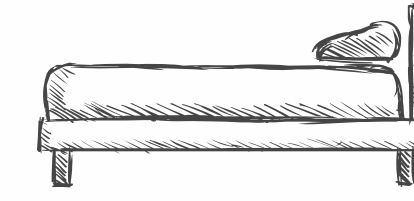

IT-41 - 4127 | SIENNA MAPLE



IT-41 - 4129 | BROWN CHESTNUT



IT-41 - 4133 | PROVINCIAL BROWN



ELAN  
AURA



IT-41 - 4138 | RUSSET BROWN



IT-41 - 4122 | COGNAC OAK



IT-41 - 4130 | LINEAR TEAK

*choose the mode of*  
luxuriousness



IT-41 - 4124 | SOFT CYPRESS



IT-41 - 4132 | LUSHIOUS OAK



IT-41 - 4135 | ESPRESSO ASH



ELAN  
AURA

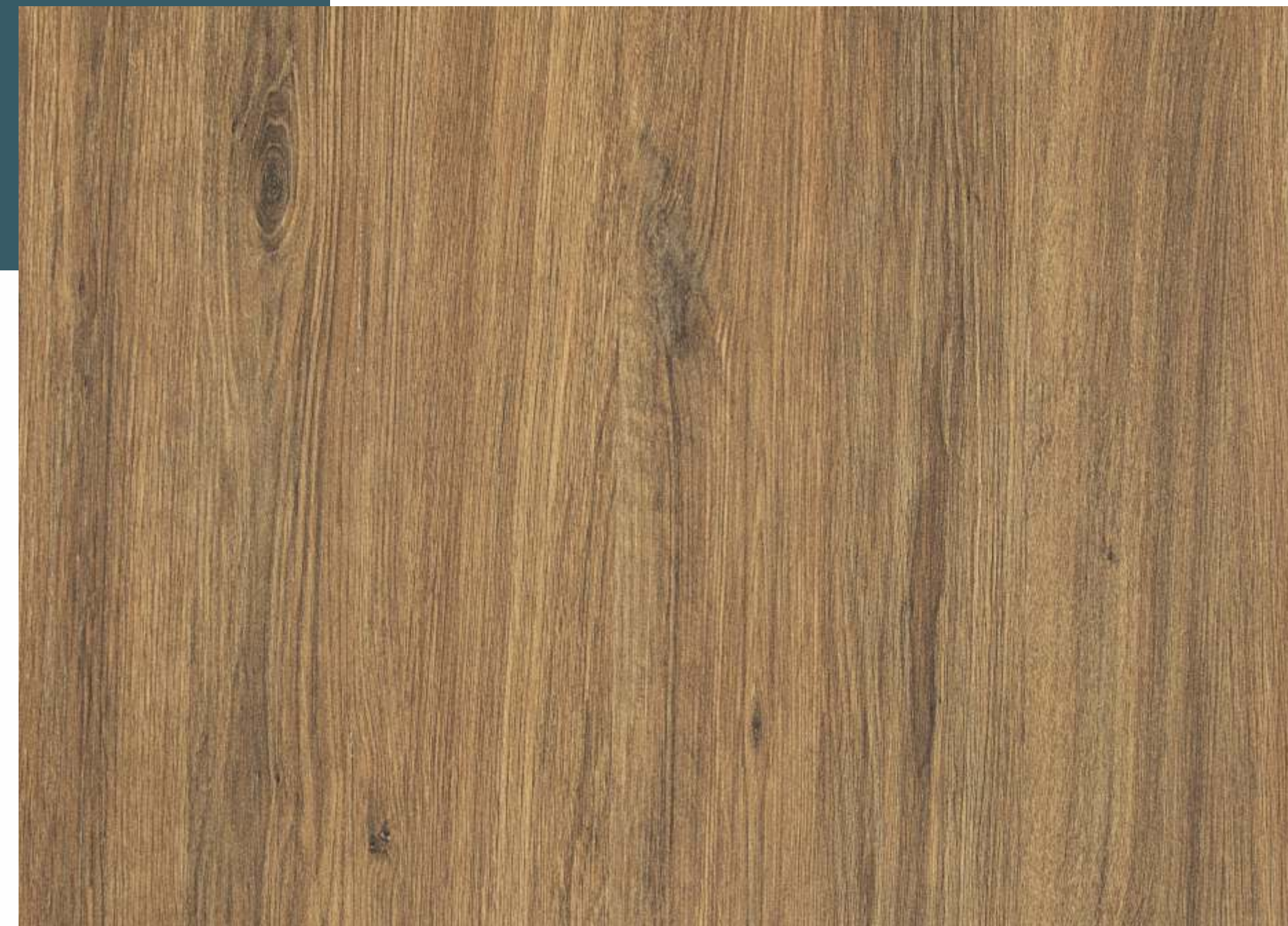

IT-41 - 4116 | MESH MAHOGANY



IT-41 - 4105 HZ | ACCENT BROWN

*coziness has a different*  
**Zeal**



IT-41 - 4119 | WISHFUL GREY



IT-41 - 4120 | BROWN CINNAMON



# MAJESTIC

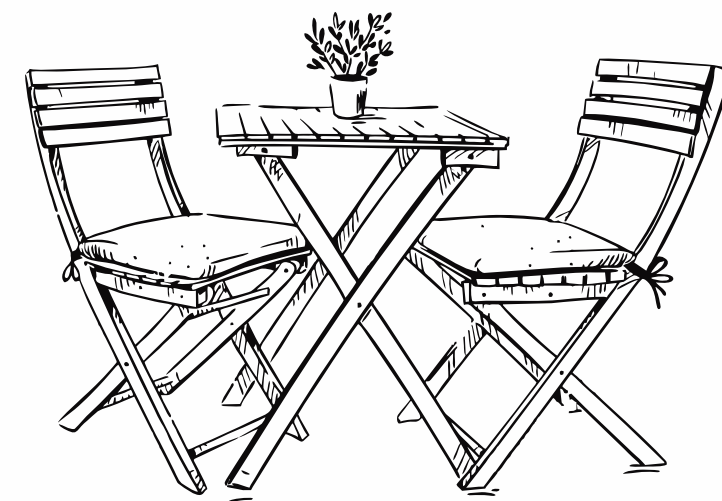

IT-48 - 423 | CITRUS ORANGE



IT-51 - 4601 | BLACK CORDOVAN



IT-51 - 4602 | PEBBLE PINE



USED LAMINATE  
IT-51 - 4140 ◆◆

*gather the gorgeous*  
**wonder**



IT-51 - 4140 | SEDONA RED



# BOHEMIAN



IT-27 - 4124 | SOFT CYPRESS

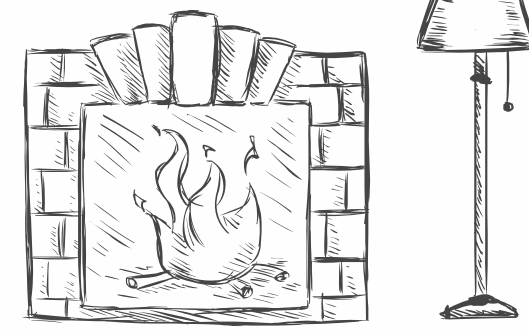

IT-27 - 4125 | DRIFTWOOD

*gradients of gorgeous*  
**timber**



IT-27 - 4116 | MESH MAHOGANY



IT-27 - 4114 | POPLAR PANACHE



IT-27 - 4115 | TEAK REALM



SLEEK  
TENOR



*vigor has its*  
**distinctness**

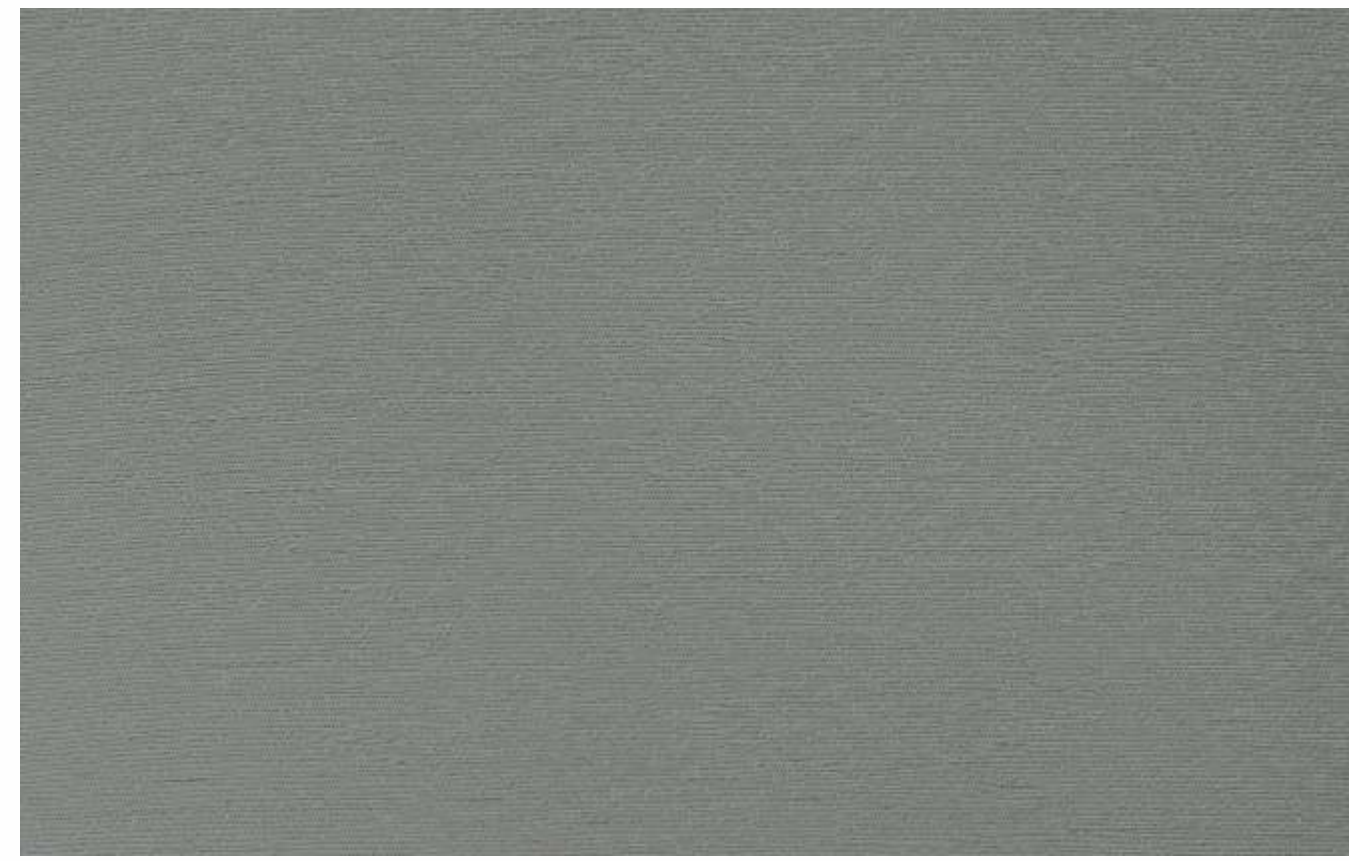

IT-42 - 4502 | STONE GREY



IT-42 - 4501 | CINEREOUS GREY



IT-42 - 4503 | SLATE GREY



IT-42 - 4504 | GREY DAZZLE



# CONTEMPORARY



IT-28 - 4110 | GREY GRACIO



IT-28 - 4113 | WAVY BLACK



IT-28 - 406 | FROSTY WHITE



IT-28 - 430 | BLACK

*breath-taking touch of*  
**trend-setters**

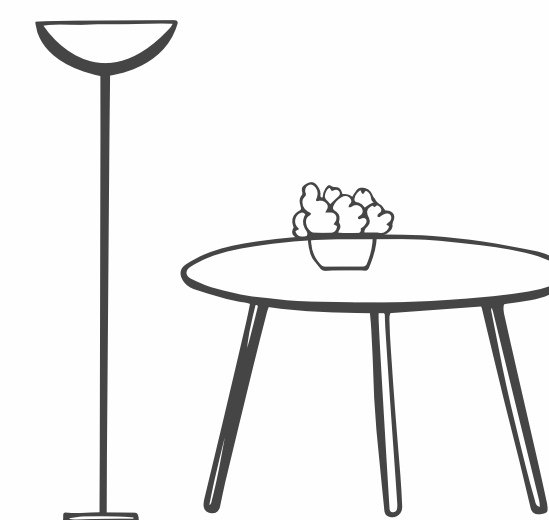

IT-28 - 4128 | COFFEE BROWN



IT-28 - 412 | PEWTER GREY



IT-28 - 413 | SLATE GREY



IT-28 - 4136 HZ | GLAUCOUS GREY



USED LAMINATE  
IT-28 - 4128



IT-28 - 414 | BROWN



IT-28 - 411 | SILVER GREY



CONTEMPORARY



IT-28 - 4109 | CHOCOLATE OAK

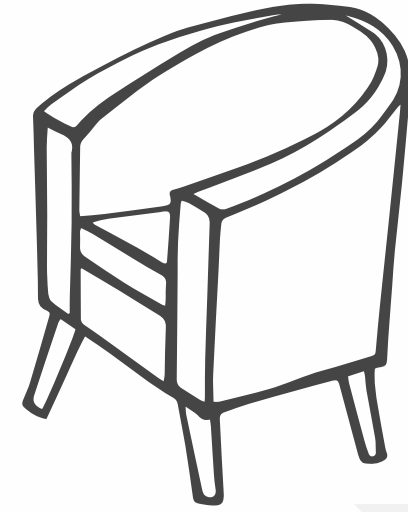

cherish the royal touch



USED LAMINATE  
IT-28 - 4108

USED LAMINATE  
IT-28 - 4109



IT-28 - 4108 | LINEA PINE

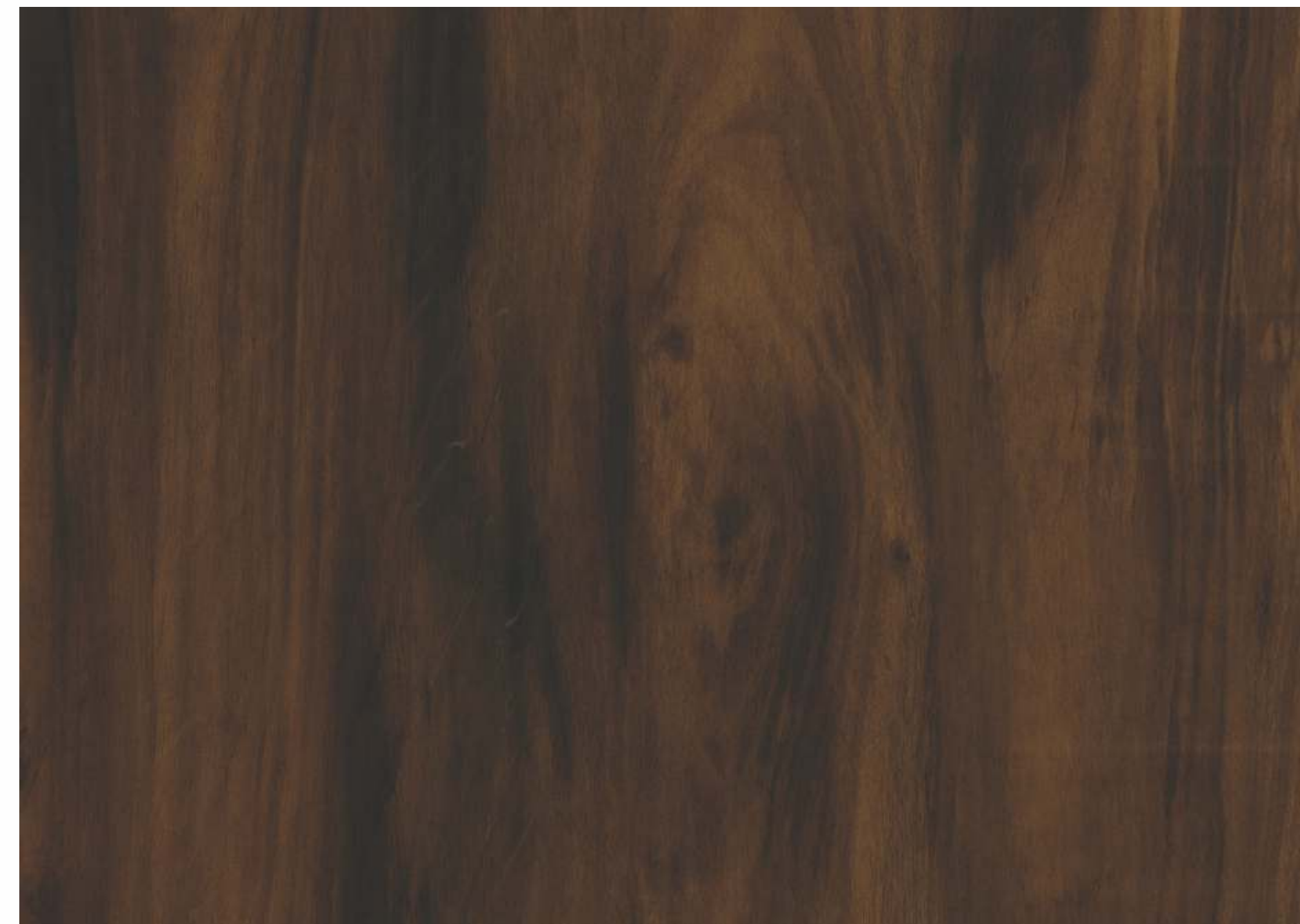

IT-28 - 43121 | ESTRO ELM WOODY



ENGAGING



IT-36 - 4112 | BLACK PATTERNIA



IT-36 - 4110 | GREY GRACIO



IT-36 - 4137 | ELITE JACOBEOAN

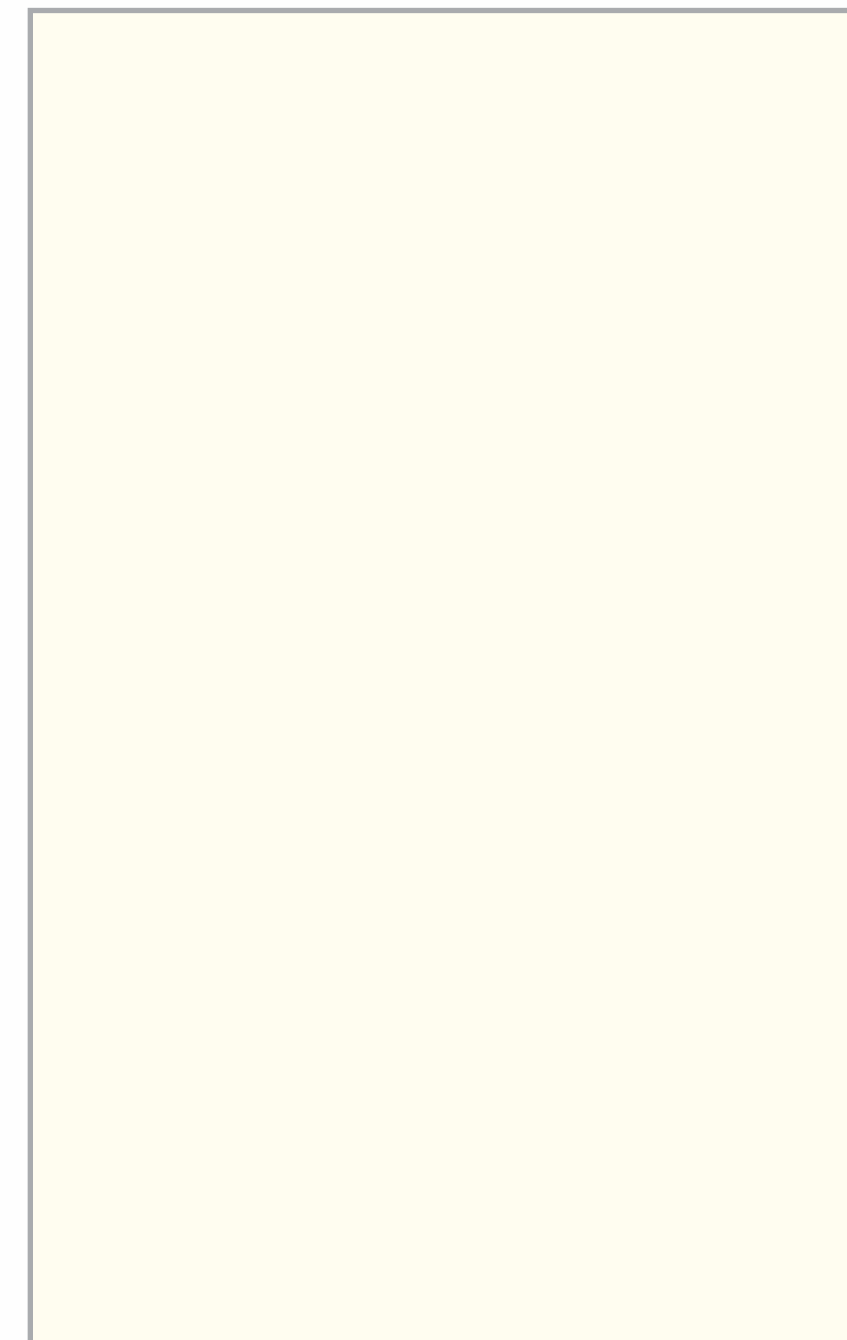

IT-36 - 406 | FROSTY WHITE



IT-36 - 430 | BLACK



PERFECTION



IT-44 - 4109 | CHOCOLATE OAK



IT-44 - 4108 | LINEA PINE



IT-44 - 4104 | CREMA ASH



IT-44 - 4103 | RUGGED BEECH

*Enchanting air of*  
**elegance**



PERFECTION



IT-44 - 4123 | COUNTY PINE



*Buoyant feel of*  
**dignity**

USED LAMINATE  
IT-44 - 4128 ♦♦



IT-44 - 4128 | COFFEE BROWN



IT-44 - 4105 | ACCENT BROWN



# RUGGEDNESS



USED LAMINATE  
IT-54 - 4603 ◆◆

*bring the glory of panache*  
**perfection**

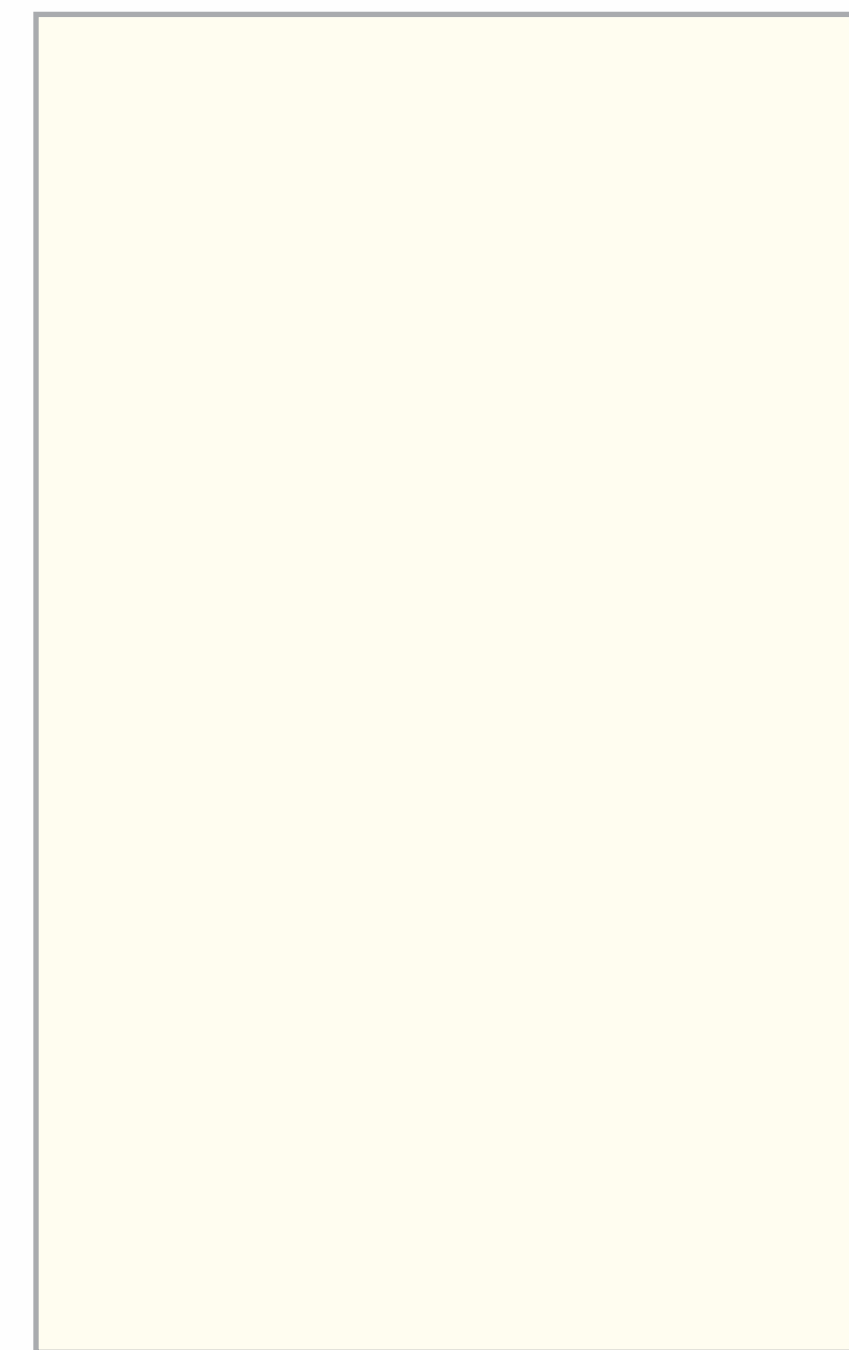
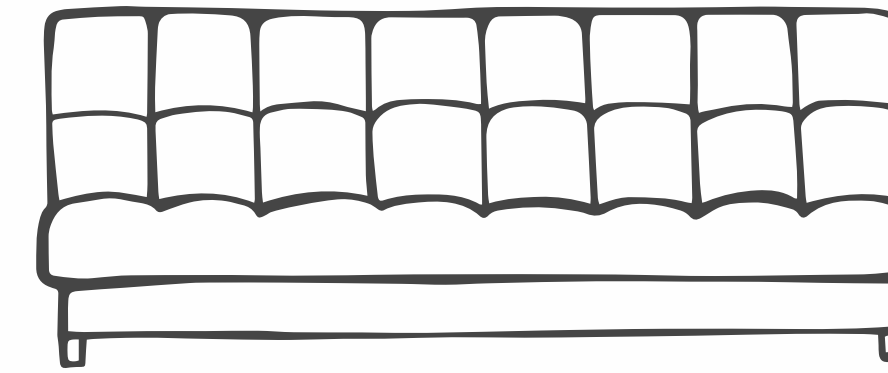
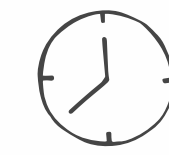

IT-54 - 406 I FROSTY WHITE



IT-54 - 4603 | MARVELLIA GREY



IT-54 - 4602 | PEBBLE PINE





# URBANITY



*precious and dignified*  
**dexterity**



IT-26 - 4116 | MESH MAHOGANY

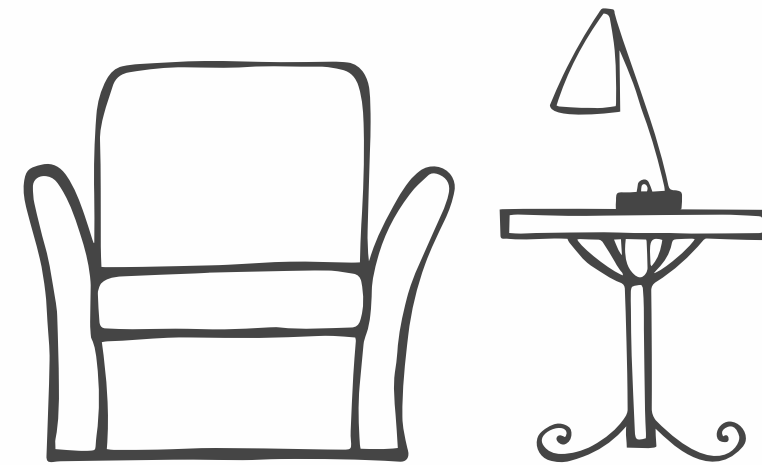

IT-26 - 4128 | COFFEE BROWN

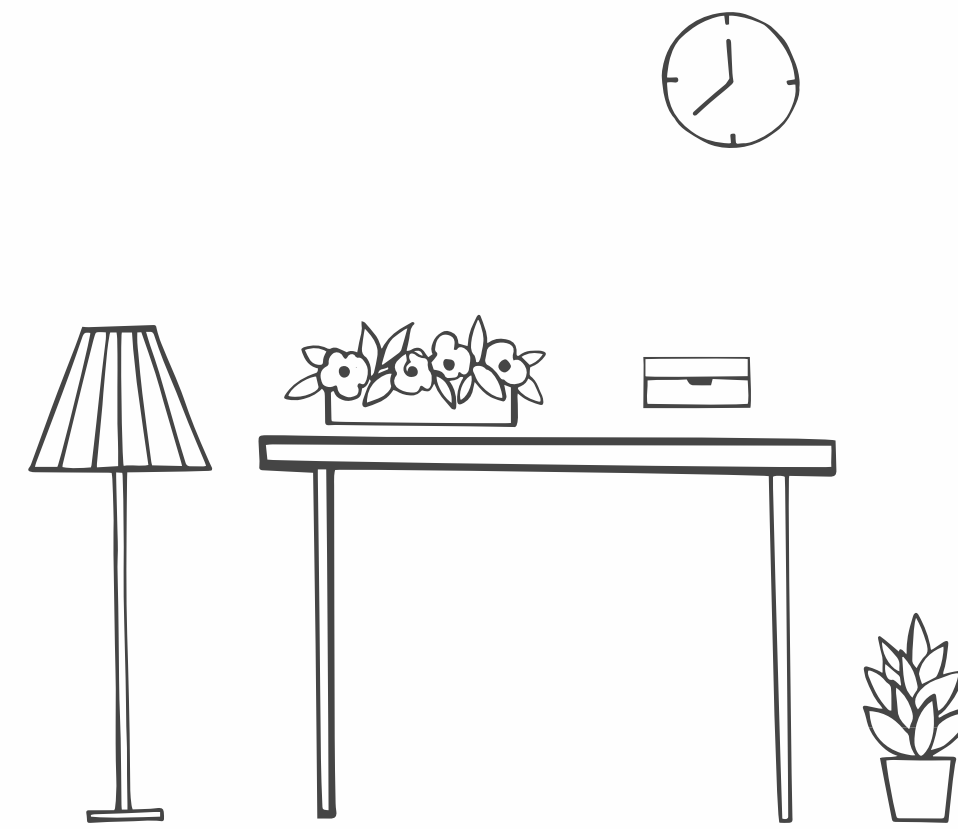

IT-26 - 4129 | BROWN CHESTNUT



IT-26 - 4130 | LINEAR TEAK





VOGISH  
VEIN



IT-49 - 4105 | ACCENT BROWN



IT-49 - 4139 | ESPRESSO ASH



IT-49 - 4123 | COUNTY PINE



VOGISH  
VEIN

*ultimate touch of plush*  
**hoise**

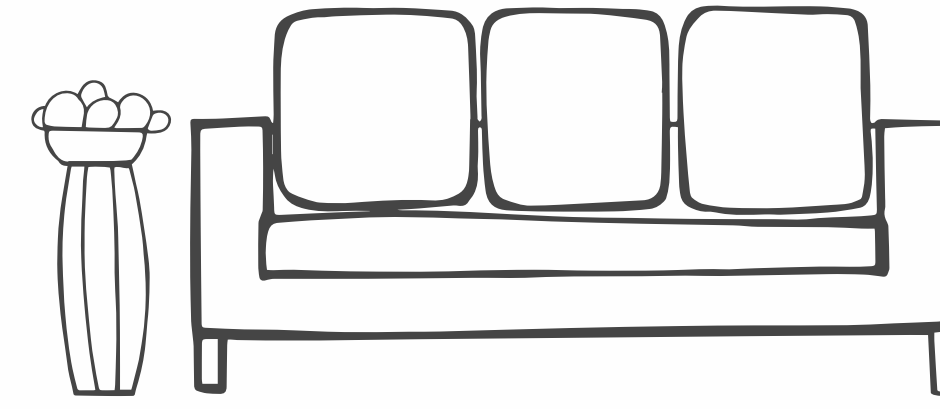

IT-49 - 4121 | BLACK DEPTHIA



IT-49 - 4141 | SLEEK WALNUT



IT-49 - 4137 | ELITE JACOBAN



IT-49 - 4136 | GLAUCOUS GREY



SUEDE  
FINISH



SF-4102 | SPHERICAL PINE



SF-4101 | BUFF BROWN



SF-4103 | RUGGED BEECH



SF-4104 | CREMA ASH



SF-4106 | GRAINY CEDAR



SF-4107 | DEEP HEMLOCK



SF-4110 | GREY GRACIO



SF-4111 | FRESCO GREY

*embrace the design*  
**fluency**



# SUEDE FINISH



SF-4112 | BLACK PATTERNIA



SF-4120 | BROWN CINNAMON



SF-4121 | BLACK DEPTHA



SF-4113 | WAVY BLACK



SF-4116 | MESH MAHOGANY



SF-4115 | TEAK REALM

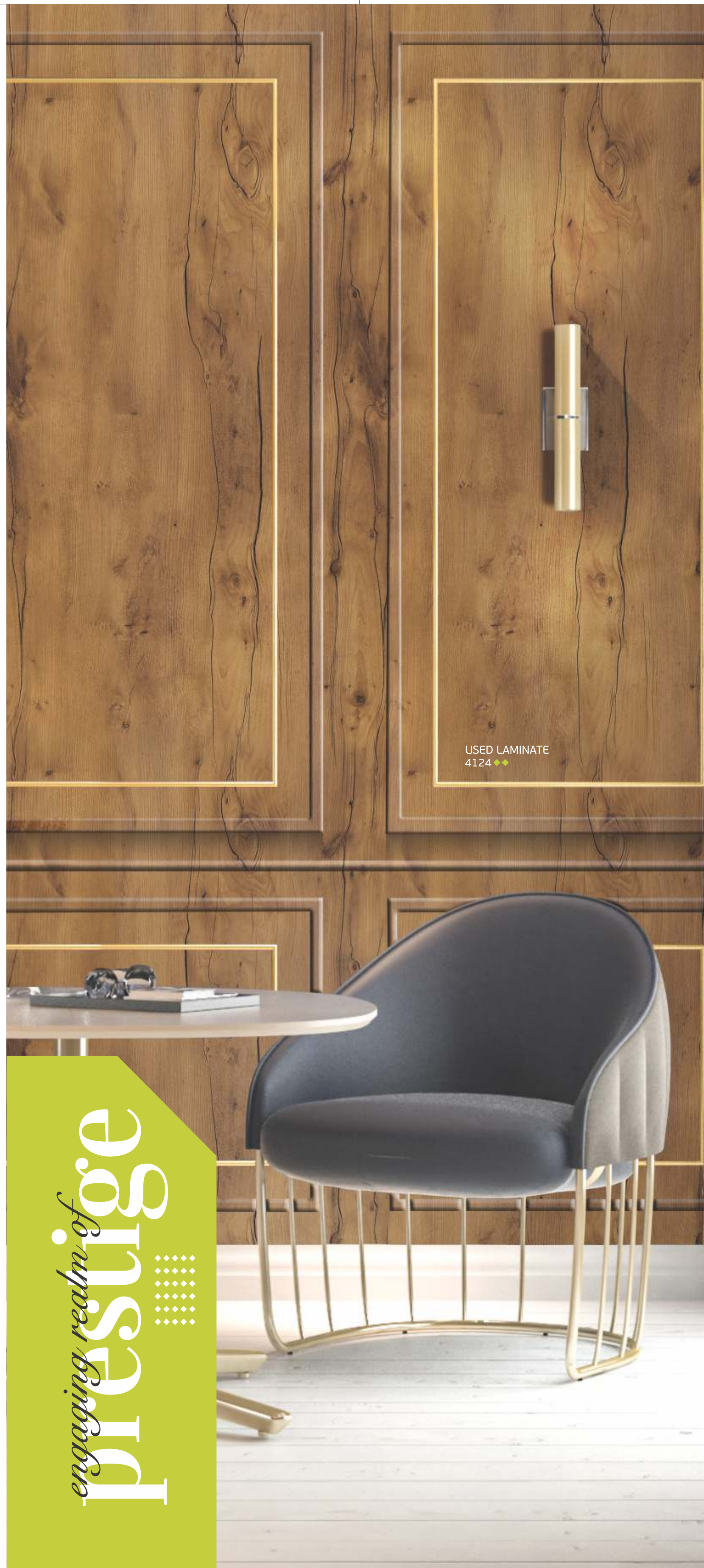

USED LAMINATE  
4124

engaging realm of  
**prestige**



SF-4125 | DRIFTWOOD



SF-4124 | SOFT CYPRESS



SF-4126 | TEAK TRIMMED



SF-4128 | COFFEE BROWN



SF-4127 | SIENNA MAPLE



SF-4129 | BROWN CHESTNUT



SUEDE  
FINISH



SF-4130 | LINEAR TEAK



SF-4131 | BRIARWOOD



SF-4122 | COGNAC OAK



SF-4119 | WISHFUL GREY

*dignified & soothing*  
**domain**





SUEDE  
FINISH



SF-4135 | ESPRESSO ASH



SF-4133 | PROVINCIAL BROWN



SF-4140 | SEDONA RED

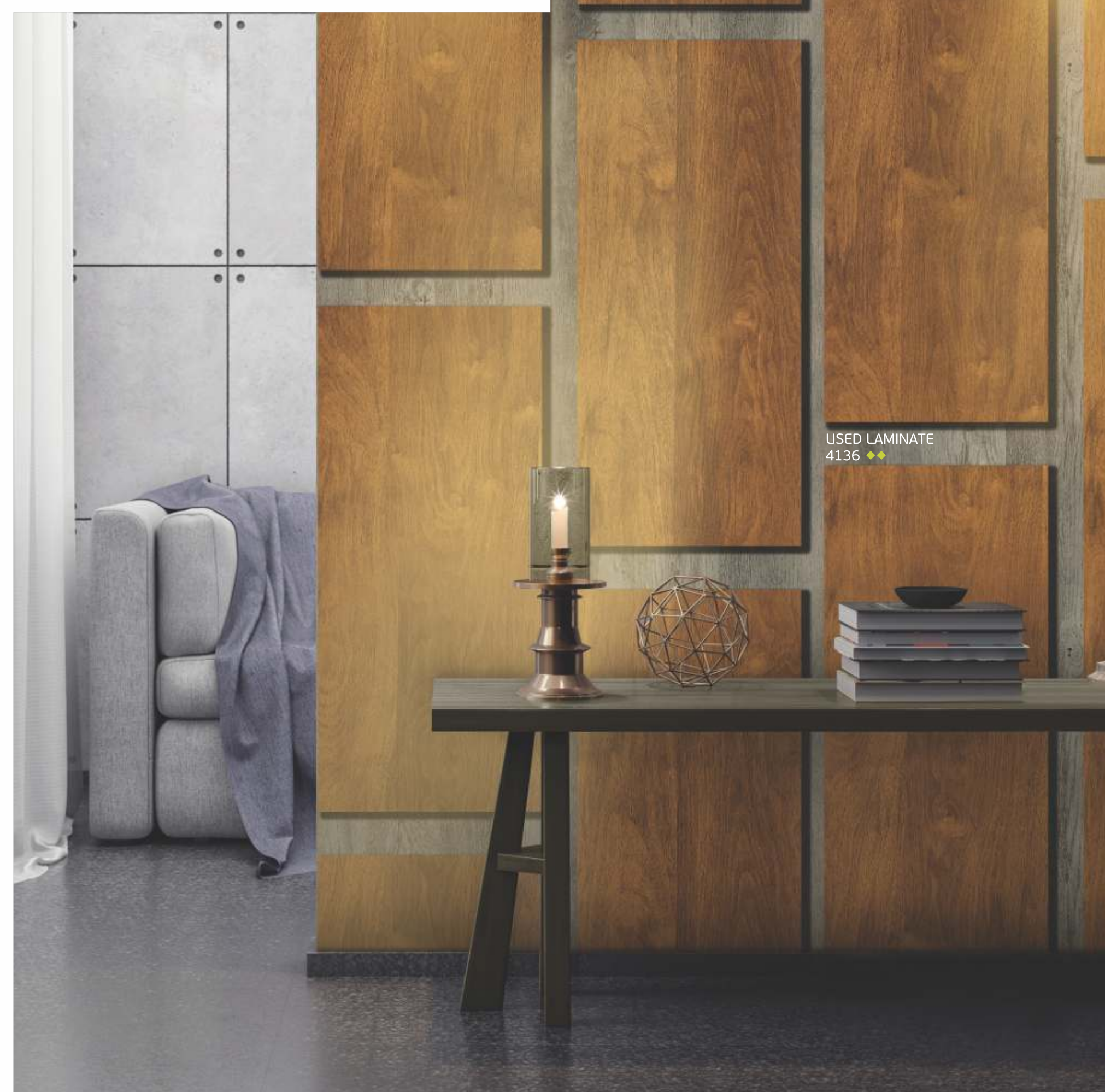

*decorum of ultimate*  
**surety**



SF-4134 | GOLDEN WALNUT



SF-4132 | LUSHIOUS OAK

SF-4136 | GLAUCOUS GREY



SF-4141 | SLEEK WALNUT



SF-4137 | ELITE JACOBAN



SF-4138 | RUSSET BROWN



# VIBRANT CODE-SF



SF-401 | SUPER WHITE

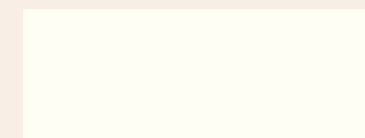

SF-406 | FROSTY WHITE

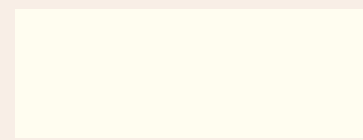

SF-404 | MAYSORE IVORY

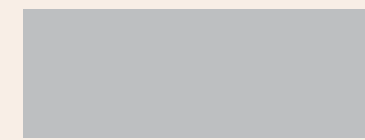

SF-411 | SILVER GREY



SF-412 | PEWTER GREY



SF-413 | SLATE GREY



SF-414 | BROWN



SF-418 | CHERRY RED



SF-430 | JET BLACK



SF-423 | CITRUS ORANGE



SF-425 | MOSAIC BLUE



SF-416 | HOT PINK



SF-415 | PINK

# VIBRANT CODE-HGL

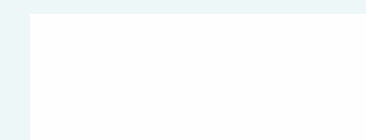

HGL-401 | SUPER WHITE

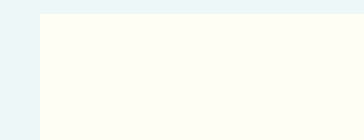

HGL-406 | FROSTY WHITE

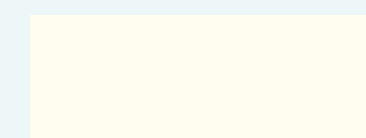

HGL-404 | MAYSORE IVORY

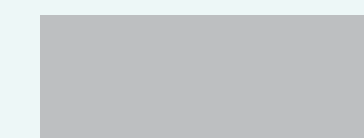

HGL-411 | SILVER GREY



HGL-412 | PEWTER GREY



HGL-413 | SLATE GREY



HGL-414 | BROWN



HGL-418 | CHERRY RED



HGL-430 | JET BLACK



HGL-423 | CITRUS ORANGE



HGL-425 | MOSAIC BLUE



HGL-416 | HOT PINK



HGL-415 | PINK



# INDEX



# TECHNICAL SPECIFICATIONS

FINISH	DESIGN NO.	DESIGN NAME	PAGE NO.	FINISH	DESIGN NO.	DESIGN NAME	PAGE NO.	FINISH	DESIGN NO.	DESIGN NAME	PAGE NO.
<b>SUBTLE TEAK</b>				<b>NICHE NATURE</b>				<b>SUEDE FINISH</b>			
IT-52	4140	SEDONA RED	05	IT-50	4103	RUGGED BEECH	30	SF	4102	SPHERICAL PINE	72
IT-52	4136	GLAUCOUS GREY	35	IT-50	4104	CREMA ASH	31	SF	4106	GRAINY CEDAR	72
IT-52	4126	TEAK TRIMMED	35	IT-50	4115	TEAK REALM	32	SF	4101	BUFF BROWN	72
<b>BOHEMIAN</b>				<b>PLUSH PENCHANT</b>				<b>CLASSIC FABRIC</b>			
IT-27	4107	DEEP HEMLOCK	06	IT-48	430	BLACK	05	IT-29	4502	STONE GREY	39
IT-27	4106	GRAINY CEDAR	06	IT-48	4504	GREY DAZZLE	36	IT-29	4501	CINEREOUS GREY	39
IT-27	4124	SOFT CYPRESS	50	IT-48	4503	SLATE GREY	36	<b>SPLENDOR WONDER</b>			
IT-27	4125	DRIFTWOOD	50	IT-48	43502	WHITE FABRIC	37	IT-53	406	FROSTY WHITE	40
IT-27	4116	MESH MAHOGANY	51	IT-48	43501	BLUE FABRIC	37	IT-53	4127	SIENNA MAPLE	41
IT-27	4114	POPLAR PANACHE	51	IT-48	4117	PECAN STREAK	38	IT-53	430	BLACK	41
IT-27	4115	TEAK REALM	51	IT-48	4118	LAYERED NUTMEG	38	<b>SLEEK TENOR</b>			
<b>PLUSH TOUCH</b>				<b>CONTEMPORARY</b>				<b>VIBRANT CODE SF</b>			
IT-43	4135	ESPRESSO ASH	08	IT-28	4110	GREY GRACIO	54	SF	401	SUPER WHITE	80
IT-43	406	FROSTY WHITE	09	IT-28	4113	WAVY BLACK	54	SF	406	FROSTY WHITE	80
IT-43	4131	BRIARWOOD	10	IT-28	406	FROSTY WHITE	54	SF	412	PEWTER GREY	80
IT-43	4130	LINEAR TEAK	10	IT-28	430	BLACK	54	SF	414	BROWN	80
IT-43	4127	SIENNA MAPLE	11	IT-28	412	PEWTER GREY	55	SF	430	JET BLACK	80
IT-43	4134	GOLDEN WALNUT	11	IT-28	413	SLATE GREY	55	SF	425	MOSAIC BLUE	80
<b>ABSTRACT</b>				<b>ENGAGING</b>				<b>VIBRANT CODE HGL</b>			
IT-31	4126	TEAK TRIMMED	12	IT-36	4112	BLACK PATTERNIA	58	HGL	401	SUPER WHITE	81
IT-31	4112	BLACK PATTERNIA	13	IT-36	4110	GREY GRACIO	59	HGL	406	FROSTY WHITE	81
IT-31	4111	FRESCO GREY	13	IT-36	4137	ELITE JACOBAN	59	HGL	412	PEWTER GREY	81
<b>MODISH WOOD</b>				<b>PERFECTION</b>				<b>VIBRANT CODE HGL</b>			
IT-35	4107	DEEP HEMLOCK	14	IT-44	4109	CHOCOLATE OAK	60	HGL	414	BROWN	81
IT-35	4106	GRAINY CEDAR	14	IT-44	4108	LINEA PINE	60	HGL	430	JET BLACK	81
IT-35	4132	LUSHIOUS OAK	15	IT-44	4104	CREMA ASH	61	HGL	425	MOSAIC BLUE	81
IT-35	4141	SLEEK WALNUT	15	IT-44	4103	RUGGED BEECH	61	HGL	415	PINK	81
<b>ELAN AURA</b>				<b>URBANITY</b>				<b>VIBRANT CODE HGL</b>			
IT-41	4102	SPHERICAL PINE	16	IT-26	4116	MESH MAHOGANY	66	HGL	404	MAYSORE IVORY	81
IT-41	4101	BUFF BROWN	17	IT-26	4128	COFFEE BROWN	66	HGL	411	SILVER GREY	81
IT-41	4606	CAROB MODERNO	42	IT-26	4129	BROWN CHESTNUT	67	HGL	413	SLATE GREY	81
IT-41	4605	MARBELLIA WHITE	42	IT-26	4130	LINEAR TEAK	67	HGL	418	CHERRY RED	81
IT-41	4129	BROWN CHESTNUT	42	<b>VOGISH VEIN</b>				<b>VIBRANT CODE HGL</b>			
IT-41	4127	SIENNA MAPLE	43	IT-49	4105	ACCENT BROWN	68	HGL	423	CITRUS ORANGE	81
IT-41	4133	PROVINCIAL BROWN	43	IT-49	4139	ESPRESSO ASH	69	HGL	416	HOT PINK	81
IT-41	4138	RUSSET BROWN	44	IT-49	4123	COUNTY PINE	69				
IT-41	4122	COGNAC OAK	44								
IT-41	4130	LINEAR TEAK	44								
IT-41	4124	SOFT CYPRESS	45								
IT-41	4132	LUSHIOUS OAK	45								
IT-41	4135	ESPRESSO ASH	45								
IT-41	4116	MESH MAHOGANY	46								
IT-41	4105 HZ	ACCENT BROWN	46								
IT-41	4119	WISHFUL GREY	47								
IT-41	4120	BROWN CINNAMON	47								
<b>CLASSIC</b>											
IT-46	4119	WISHFUL GREY	18								
IT-46	4120	BROWN CINNAMON	19								
IT-46	4140	SEDONA RED	20								
IT-46	4133	PROVINCIAL BROWN	20								
IT-46	4132	LUSHIOUS OAK	21								
IT-46	4137	ELITE JACOBAN	21								
<b>ELITE TOUCH</b>											
IT-25	4122	COGNAC OAK	23								
IT-25	4135	ESPRESSO ASH	24								
IT-25	4133	PROVINCIAL BROWN	24								
IT-25	4131	BRIARWOOD	25								
IT-25	4120	BROWN CINNAMON	25								
IT-25	4123	MESH MAHOGANY	25								
IT-25	4124	SOFT CYPRESS	26								
IT-25	4125	DRIFTWOOD	26								
IT-25	4134	COFFEE BROWN	27								
IT-25	4126	TEAK TRIMMED	27								
<b>MAJESTIC</b>											
IT-51	4603	MARVELLIA GREY	28								
IT-51	4604	BRISKISH BEECH	29								
IT-51	4601	BLACK CORDOVAN	48								
IT-51	4602	PEBBLE PINE	48								
IT-51	4140	SEDONA RED	49								

PROPERTIES	SPECIFIED VALUES AS PER IS:2046-1995, TYPE S, HGS	CONFORMS	SPECIFIED VALUES AS PER IS:2046-1995, TYPE S, HGS	CONFORMS
Resistance to surface wear	350 [Revolutions]	✓	350 [Revolutions]	✓
Resistance to immersion in boiling water - Mass increase [%] - Thickness increase [%] - Appearance	10.0 [Maximum] 11.8 [Maximum] Not worse than 4	✓	7.5 [Maximum] 8.5 [Maximum] Not worse than 4	✓
Resistance to dry heat 180° c	Not worse than 4	✓	Not worse than 4	✓
Dimensional stability at deviated temperature - Longitudinal [%] - Transverse [%]	0.55 [Maximum] 1.025 [Maximum]	✓	0.44 [Maximum] 0.86 [Maximum]	✓
Dimensional stability at 20° c - Longitudinal [%] - Transverse [%]	0.375 [Maximum] 0.60 [Maximum]	✓	0.31 [Maximum] 0.49 [Maximum]	✓
Resistance to impact by small diameter ball	20 N [Minimum]	✓	20 N [Minimum]	✓
Resistance to cracking	Not worse than 4	✓	Not worse than 4	✓
Resistance to scratching	2 N [Minimum]	✓	2 N [Minimum]	✓
Resistance to staining	Not worse than 5	✓	Not worse than 5	✓
Resistance to colour change [wood standards] - In xenon arc light - In enclosed carbon arc light	Not worse than 6 Not worse than 5	✓	Not worse than 6 Not worse than 5	✓
Resistance to cigarette burns	Not worse than 3	✓	Not worse than 3	✓
Resistance to steam	Not worse than 4	✓	Not worse than 4	✓
Appearance	Should be free from foreign particles	✓	Should be free from foreign particles	✓

Grades : General and fire retardant [FR]  
Types : Standard, post forming, compact, cabinet liners, backer  
Size : 2440 mm x 1220 mm [8'x4']  
Thickness : 1mm [±10%]

Care & Maintenance : Cleaning should be carried out with a soft moist cloth and warm soap solution. Do not use detergents containing abrasive particle or excess soda.

- Design from genuine imported base paper.
- Manufactured using best quality kraft paper.
- Use of best chemical raw materials for better flexibility & durability.

Do not use nail and hammer while cutting such Corner, Grew, Angle, and Designs.  
Use only drill while cutting such Corner, Grew, Angle and Designs.



SANDING SAMPLE



1MM THICKNESS SAMPLE